

MICRO-ONDAS
VETRO FLAT
23 LITROS

FMC-LT-25-VT-2GZA

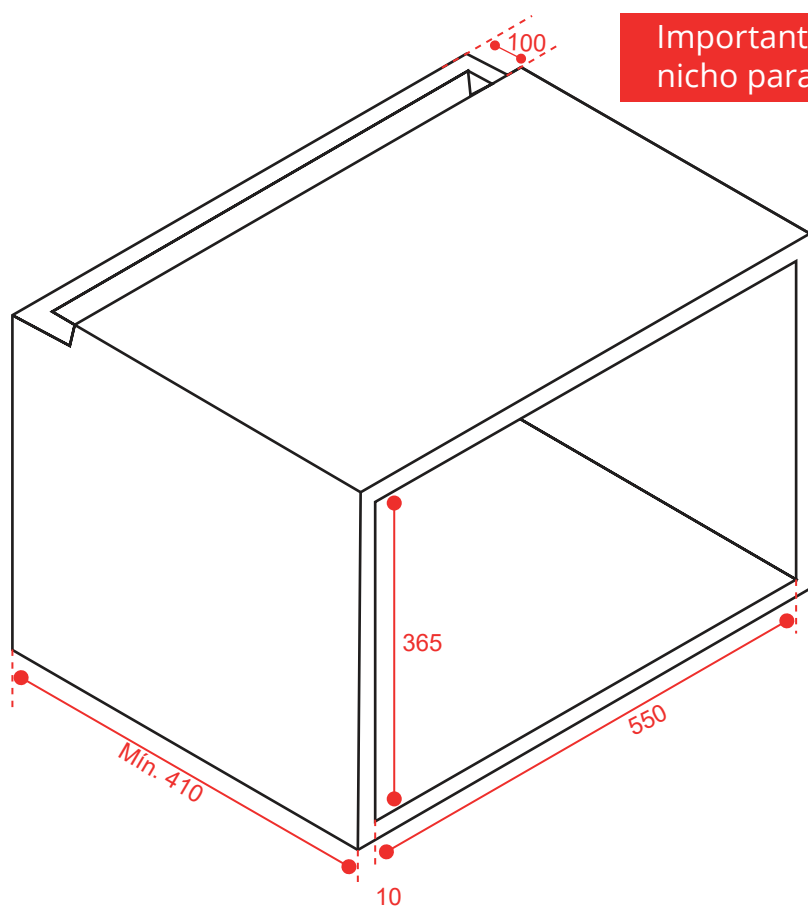
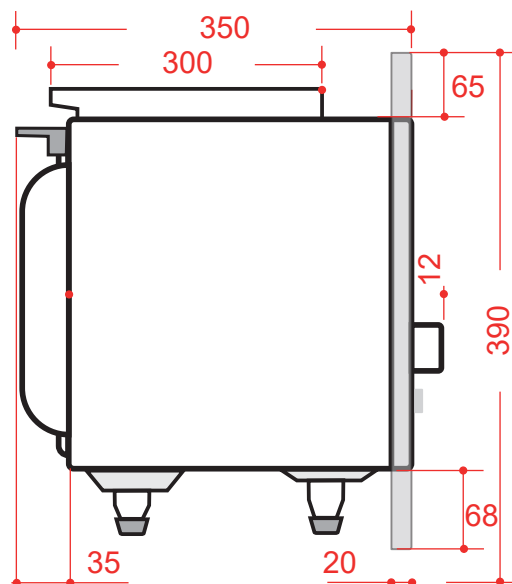
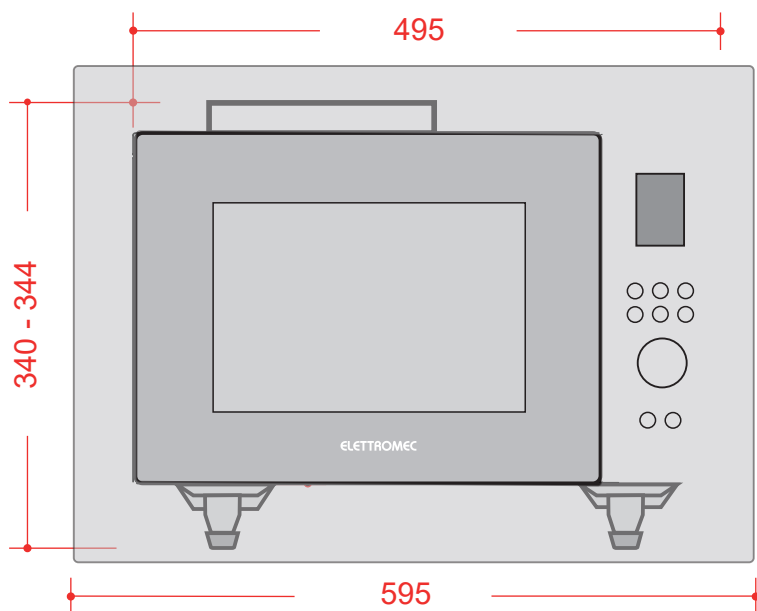

Importante respeitar abertura superior no nicho para a ventilação adequada do produto.

2020-11-25 - V1-R2
Medidas em milímetros